



ProLine Pest Control System User Manual



*P-01-PL-00248 shown, your system may vary

Table of Contents

Section Title	Page
Safety Rules.....	2
System Compatibility.....	3
PowerPack Components.....	3
Tank Components.....	4
Wand & Tip Assembly.....	5
Wand Styles.....	5
Wand Handle Assembly.....	6
Wand Extension Assembly.....	6
TJ66 Extension Assembly.....	6
Pro31 Extension Assembly.....	7
Tip Styles.....	8
Tip Assembly.....	8
TJ66 & Pro31 Tip Assembly.....	9
PS30 Tip Assembly.....	10
PowerPack Operation.....	11
PowerPack Attachment.....	11
PowerPack Removal.....	11
PowerPack Charging.....	12
PowerPack Usage.....	13
Tank Operation.....	14
Filling.....	14
Pressure Relief System.....	15
Cleaning & Maintenance.....	16
Tank Replacement Parts.....	17
PowerPack Replacement Parts.....	18
Warranty & Contact Information.....	19

Safety Rules

Congratulations on purchasing the first intelligent compressed air spray system. With the Green Gorilla ProLine Spray System you now have precision control when applying your product. Your Green Gorilla ProLine tank is equipped with a patented Quick-Connect fitting that allows the PowerPack to easily attach to the tank, completely automating the pressurization process and precisely controlling the pressure using Smart Pressure Technology (SPT™).

The instructions and maintenance tips provided in this owner's guide will assist you in the care of your Green gorilla ProLine tank. Be sure to read all warnings and follow all instructions before using the sprayer.

Warning and Cautionary Statements

- ▲ Warning: When using solvent based products ensure the area is well ventilated with no open flames. Fumes generated by certain products can be injurious to your health. Always operate the sprayer in well ventilated areas and don protective equipment per the manufacturer's recommendations for the product being delivered. Never spray solvent based products in an enclosed area.
- ▲ Warning: Never charge the PowerPack in temperatures below 32° F or above 110° F. This can result in battery damage and/or fire.
- ▲ Warning: It is imperative that the original charger for the Green Gorilla system is used as different chargers may not have the built in protection necessary to ensure a safe charging condition.
- ▲ Warning: Do not pressurize the tank with anything other than genuine Green Gorilla parts and accessories.
- ▲ Warning: Do not use mechanical devices to pressurize tank other than recommended Green Gorilla Power Packs and accessories.
- ▲ Warning: Do not stand over tank while tank is pressurized. Securely tighten hand pump as instructed; a loose pump could be forcibly ejected.
- ▲ Warning: Do not alter or plug Quick-Connect valve, sprayer could explode. This is a safety device.
Caution: Do not fill tank above listed operating capacity.
Caution: Do not pressurize sprayer until ready to use or leave pressurized sprayer unattended.
Caution: Do not lift or carry sprayer by hose.
Caution: Do not use solutions hotter than 105° F. Damage may occur.
Important: Triple rinse tank and pressure relief valve between chemical change outs to ensure no cross contamination.
Caution: Do not store outdoors or leave PowerPack in the rain. PowerPack is water resistant but not water proof.
- ▲ Warning: Do not charge the PowerPack in the rain or damp location. Charge in warm, dry location only.

System Compatibility

IMPORTANT! This system includes Viton® seals that are appropriate for petroleum based products, water based products, and most pest control products. Follow all manufacturers' recommendations for protective clothing and product usage.

PowerPack Components

Carefully unpack the tank, PowerPack, and all loose items from the carton and assemble as outlined in this guide.



fig. 1

Tank Components

Carefully unpack the tank, PowerPack, and all loose items from the carton and assemble as outlined in this guide.

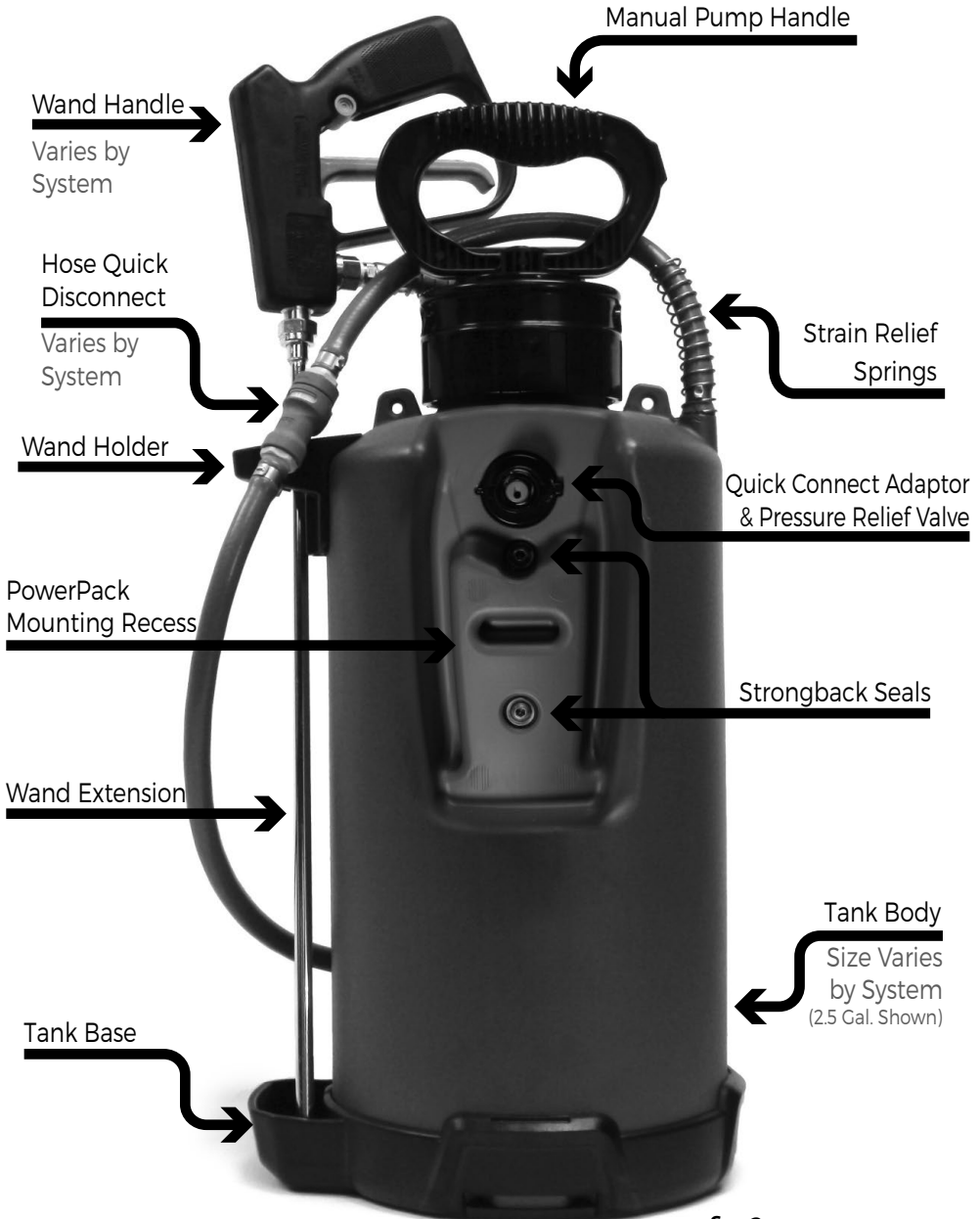

fig. 2

Wand & Tip Assembly

Wand Handle Styles

Your system can be configured with one of three different wand types, Figure 3 below identifies each wand style. To complete the wand extension and tip assembly you will need a 13/16" and 9/16" open end wrench. *Note: Some systems are pre-assembled, and require no additional assembly. "Foundation" systems and tanks do NOT include wands. Please apply these instructions as needed for your unit.*

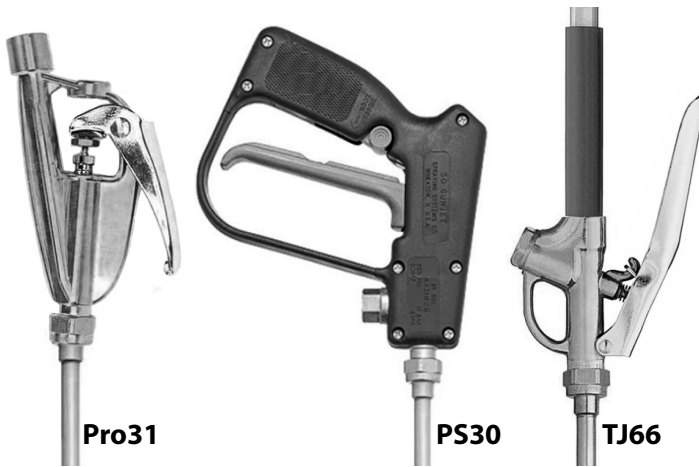

fig. 3

Pro31: The Pro31 wand handle incorporates a shutoff valve at the handle and is typically equipped with an 8" curved end extension for the 1.5 gallon tank size and the 18" curved end extension for the 2.5 gallon tank. This wand incorporates a strainer at the end of the wand extension as outlined in Figure 18 and requires periodic maintenance to clean the filter/strainer. Figures 4 & 5 and Figures 7-11 detail the assembly process of the extension and tank hose.

PS30: The PS30 wand is a drip-less style wand with a positive shutoff valve at the tip. The shutoff is controlled by a solid rod that runs down the length of the wand extension. The wand extension is assembled at the factory and tested. The 1.5 gallon tank size typically comes with an 8" wand extension and the 2.5 gallon tank size with an 18" wand extension. Figures 21 - 25 detail the assembly steps for the tip.

TJ66: The TJ66 is a trigger valve style wand and can be equipped with many different straight extension lengths. This wand commonly comes with the 18" straight wand extension. Figure 6 details the wand extension assembly.

Wand Handle Assembly

To attach your wand handle to the tank, a 9/16" wrench is required. The 1/4" NPT wand hose fitting is pre-wrapped with Teflon tape to ensure a leak tight joint. Thread the wand hose fitting into the end of the wand handle and tighten in a clockwise direction using the 9/16" wrench. All Green Gorilla tank hoses and wand handles use the standard 1/4" NPT fitting.

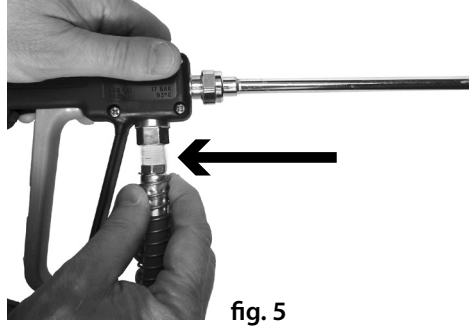
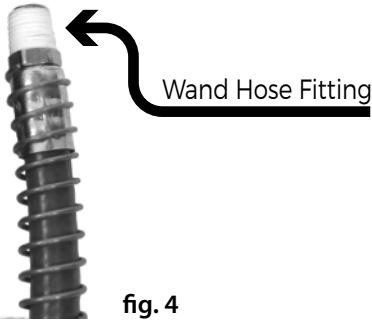

Wand Extension Assembly

TJ66: Figures 16 - 20 detail the assembly of the Style A or B tip to the TJ66 wand extension. The TJ66 wand extension is assembled to the TJ66 wand handle as outlined in Figure 6.

Pro31: Figures 16 - 20 detail the assembly of the Style A or B tip to the Pro31 wand extension. The Pro31 wand extension is assembled to the Pro31 wand handle as outlined in Figures 7 - 11.

PS30: The PS30 Wand extension is assembled at the factory and tested. No assembly is required.

TJ66 Extension Assembly

Assemble the wand extension to wand handle. Tighten the wand extension nut using a 13/16" wrench in the clockwise direction to ensure a tight metal-to-metal seal between seating surfaces. Securely hold the wand handle in place while tightening.



Pro31 Extension Assembly

Assemble wand extension to wand handle. Draw back spray handle trigger to retract the shutoff valve at the extension opening (as shown below in figures 7 & 8). Hold trigger in place and assemble the Teflon seal and o-ring as shown in figures 9 & 10.



fig. 7



fig. 8

Set Teflon shutoff at extension opening, while keeping the plunger drawn back (as shown in figure 9).



fig. 9



fig. 10

Rest the o-ring on the Teflon shutoff, while keeping plunger drawn back (as shown in figure 10)

Lastly, thread on the wand extension and securely tighten in the clockwise direction (as shown in figure 11), and work the spray trigger 2-3 times before finally releasing it. Tighten the brass nut using a 13/16" wrench.



fig. 11

Tip Styles

There are two styles of tip assemblies; Style A - adjustable pin to cone (Figure 12) and Style B - pattern specific (Figures 13 & 14). The Style B pattern specific tip assembly is detailed in Figure 15 (typical).

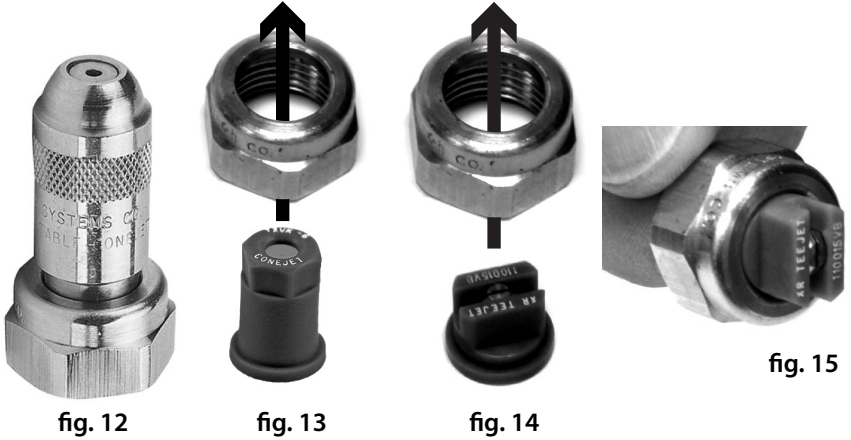

For the style B tip shown in figures 13 & 14 (which includes specialty tips such as fan patterns, cone patterns, and directional patterns), ensure that the tip aligns and seats correctly into the brass nut.

IMPORTANT! The clearance between the brass nut and the tip is close. Care should be taken when inserting the tip into the brass nut for proper seating.

Tip Assembly

TJ66 & Pro31: Figures 16 - 20 detail the Style A or B tip assembly to the TJ66 or Pro31 wand extension.

PS30: Figures 21 - 25 detail the style A or B tip assembly to the PS30 wand extension.

TJ66 & Pro31 Tip Assembly

Assembly of the tip and optional strainer is identical for both the TJ66 and the Pro31 wand handle assembly.

Optional Strainers & Strainer/Shutoffs: Assemble optional strainer (if so equipped), by inserting strainer into the end of the wand extension, as shown in figures 16 - 18.



fig. 16



fig. 17
Strainer/Shutoff



fig. 18
Strainer

Tip Assembly: Thread the 13/16" brass nut onto the end of the wand extension and tighten in the clockwise direction using a 13/16" wrench.

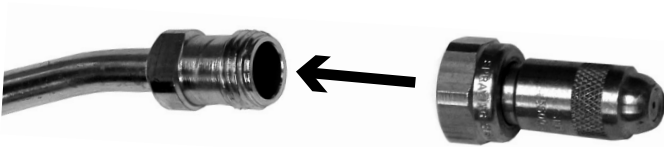

fig. 19



fig. 20

PS30 Tip Assembly

To assemble the tip to the extension, draw back spray handle trigger to retract plunger at the extension end (as shown in figures 21 & 22). Hold in place until the tip is securely fastened.

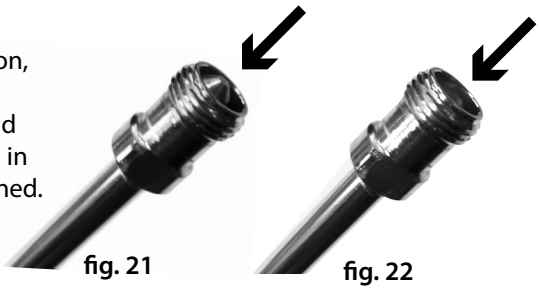

Set Teflon shutoff at extension opening, while keeping the plunger retracted (as shown in figure 23).



Rest the o-ring on the Teflon shutoff, while keeping plunger drawn back (as shown in figure 24)

Lastly, thread on the tip securely (as shown in figure 25), and work the spray trigger 2-3 times before finally releasing it. Tighten the brass nut in the clockwise direction using a 13/16" wrench.

PowerPack Operation

PowerPack Attachment

Rest the bottom of the PowerPack on the bottom of the tank's PowerPack mounting recess (as shown above in figure 26) and tilt upwards into the pocket and engage the quick connect fitting (as shown below in figure 27), until a positive click is heard. PowerPack is now ready for use.



fig. 26



fig. 27

PowerPack Removal

To remove the PowerPack from the tank, rotate the release knob in the COUNTER-CLOCKWISE direction until the knob indicator is in-line with the arrow on the housing (figure 28). Pull the PowerPack away from the tank to fully remove (figure 29).

Note: the knob is spring loaded, and will automatically reset back to the vertical attachment position.

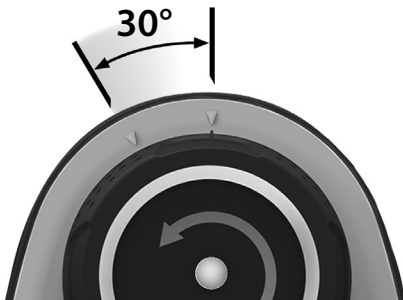

fig. 28



fig. 29

PowerPack Charging

This unit is equipped with the latest in lithium ion power technology. Ensure that you are only using the Green Gorilla 110Vac charger that came with this unit. The charger has been matched to the solid state electronics within the PowerPack itself to ensure safe and reliable charging.

IMPORTANT! A safety interlock system incorporated into this system will not allow the PowerPack to operate when the charger plug is engaged.

The wall charger is equipped with an indicator light that indicates when your system is fully charged. The indicator light (as shown in Figure 30) is red during charging periods and turns green when the lithium ion cells are fully charged. The following steps should be used when charging your PowerPack.

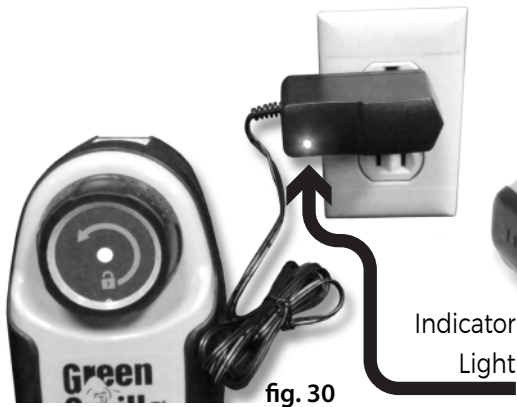

1. Insert the Green Gorilla standard wall charger into a 110 Vac wall outlet.
2. Locate the charging port cover on your PowerPack X. The charging port cover is located on the right side of the PowerPack as shown in Figure 31.
3. The charging port is protected by a flip open cover. Gently pull up on the tab to expose the charging port.
4. Firmly insert the wall charger plug into the port.
5. The wall charger indicator light will turn green when the lithium ion cells are fully charged. Charge time is approximately 3-5 hrs.
6. After fully charging, remove the charger plug from the PowerPack charging port and push the protective cover back into place.
7. Ensure that the PowerPack X battery level indicator shows green when the unit is turned on.

IMPORTANT! If the PowerPack fails to turn on after charging, pull back the protective cover and gently reinsert. A built-in safety interlock system that prevents usage while charging may have become engaged due to overinsertion of the protective cover.



PowerPack Usage

fig. 32

Turn PowerPack on by depressing the on/off power button on the top surface of the PowerPack as shown above (figure 32).

If fully charged, a green light will display on both the top surface and the center of the knob. Both the knob indicator light and the power level indicator are synchronized to indicate power depletion during normal operation. Green = Full Charged, Yellow = Half Charge, Red = Low Battery (figures 33 & 34).

During normal operation, the PowerPack will automatically cycle to maintain the factory pressure set point as necessary. The Power Level Indicator Lights will remain on to indicate the PowerPack is in pressure sensing mode.

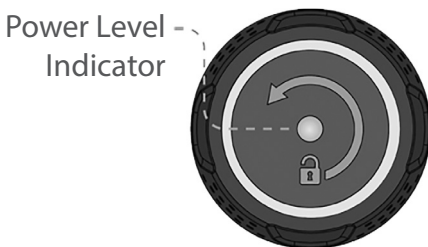

fig. 33

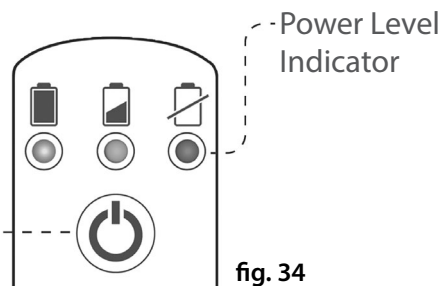

fig. 34

IMPORTANT! After filling and pressurizing the system purge air from the wand and wand hose by spraying product into a container until no air or air bursts are detected. Inadequate purging of the system may initially result in uneven spray pattern or a longer than expected flow after the wand trigger has been released.

Tank Operation

Prior to first use, it is highly recommended that an initial rinsing of the tank be performed. This is to ensure that any debris resulting from manufacturing has been removed prior to running liquid through the wand. This will minimize clogging of the strainer or wand tip and ensure proper wand operation.

Filling

Prior to filling, disconnect the PowerPack, to reduce solution spills onto the unit (see page 11, PowerPack Removal).

Mix your solution as directed by the manufacturer's instructions, and fill tank to desired level (careful not exceed the maximum working volume of your tank).

Assemble the manual pump and handle onto the top of the tank by engaging threads and rotate clockwise until the o-ring seal [under-side of cap] is fully seated (figure 35).

Lock handle in place by rotating the pump handle 90 degrees clockwise until a positive click is felt.



fig. 35

IMPORTANT! Do not carry the tank by the handle until the handle is in the locked position. Damage may occur.

Seat the pressure relief valve by depressing the red pin on the Quick Connect Adaptor 2-3 times as shown in figure 36. Completion of this step is to ensure seating of the internal seals.



fig. 36

Attach PowerPack (see page 11, PowerPack Attachment).

Pressure Relief System

The Green Gorilla ProLine sprayer is equipped with a patented Quick Connect Adaptor, see figure 2. In addition to the quick connect functionality, the Quick Connect Adaptor serves as both a manual and automatic pressure relief system.

During operation of the system, if the pressure in the tank exceeds the system design pressure the pressure relief valve will automatically open and depressurize the system to the system design pressure. The pressure relief valve will reset automatically when the tank pressure is returned to the system design pressure. This functionality works with or without a PowerPack attached to the Quick Connect Adaptor. This is a safety feature of the Green Gorilla system and should not be altered or disabled.

At any time, you may manually release the tank's pressure by depressing the red pin in the center of the Quick Connect Adaptor. (figure 37) Always keep your face clear of the Quick Connect Adaptor when releasing pressure and wear protection as recommended by the chemical manufacturer.

IMPORTANT! Prior to removing the manual pump cap, release the pressure manually at the Quick Connect Adaptor (depress red pin). Releasing pressure by this method allows for easier removal of the manual pump cap.



fig. 37

Cleaning and Maintenance

1. If tank is pressurized, RELEASE AIR PRESSURE by depressing the red pin in the Quick Connect Adaptor. (figure 37) Push red pin in firmly and hold to allow all pressure to escape.
2. Loosen manual pump slowly (figure 35) and remove by rotating in the counter-clockwise direction. (You may need to push down on the handle slightly to unlock it.) Properly store any remaining spray solution per the manufacturer's recommendation. Triple rinse all parts thoroughly with clean water.
3. To flush the hose and wand, leave a small amount of clean water in tank, pressurize and flush by depressing spray handle trigger for approximately 30 seconds. Release the pressure as outlined in step 1.
4. Drain the wand handle, extension, and hose by holding the wand handle above the the tank and depressing the trigger. This will allow all trapped water to drain back into the depressurized tank.
5. Clean the spray wand's nozzle orifices using a small cleaning brush set.
6. Always store tank indoors and empty and with the manual pump loose. If the tank is to be stored outdoors, during freezing temperatures, the tank and wand should be flushed with RV/Marine Anti-freeze to prevent equipment damage.
7. If Quick Connect Adaptor pressure relief valve (figure 37) is dirty, clean with fresh water.

IMPORTANT! Do no store tank under pressure for extended periods.

Tank Replacement Parts

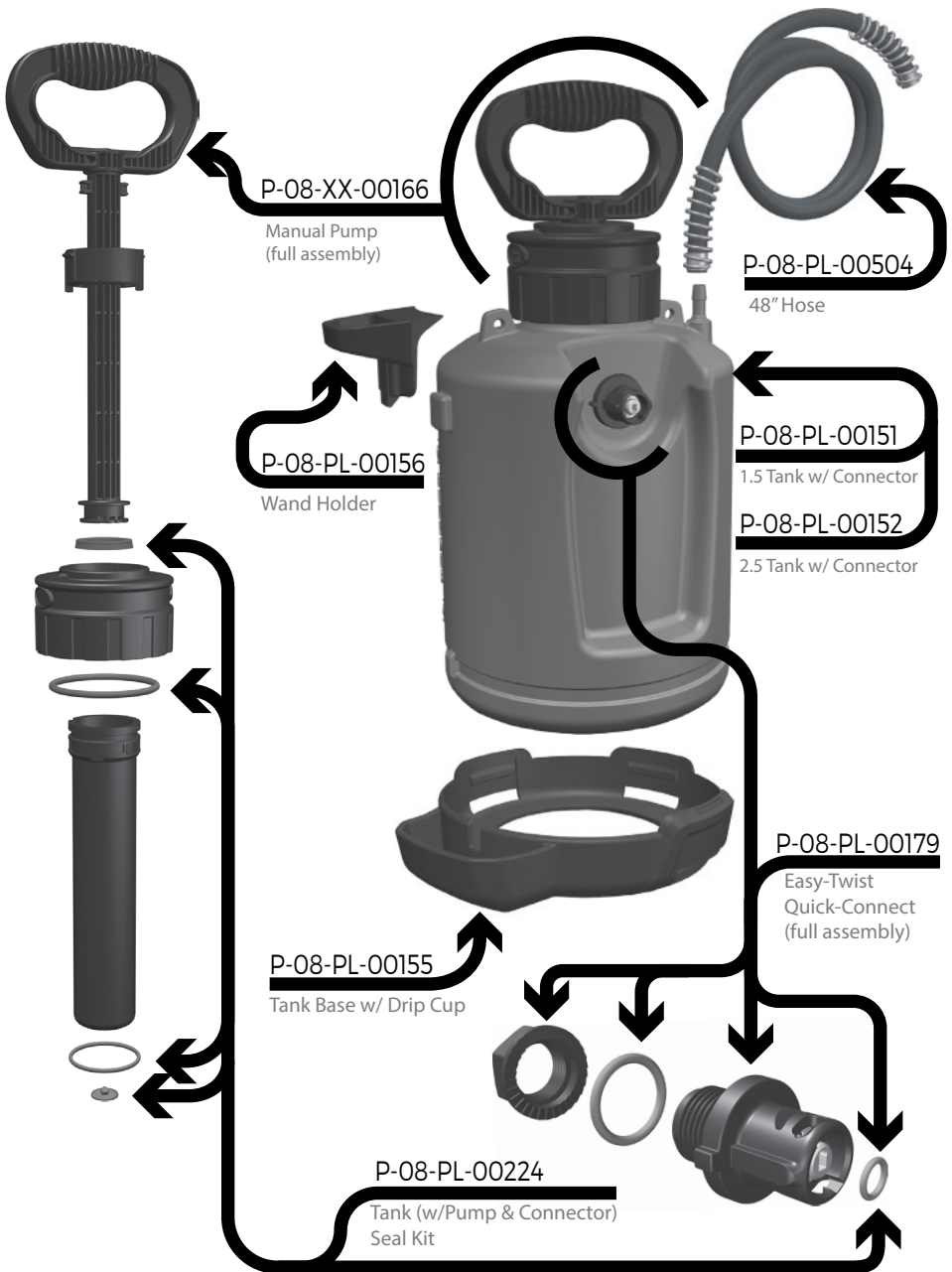
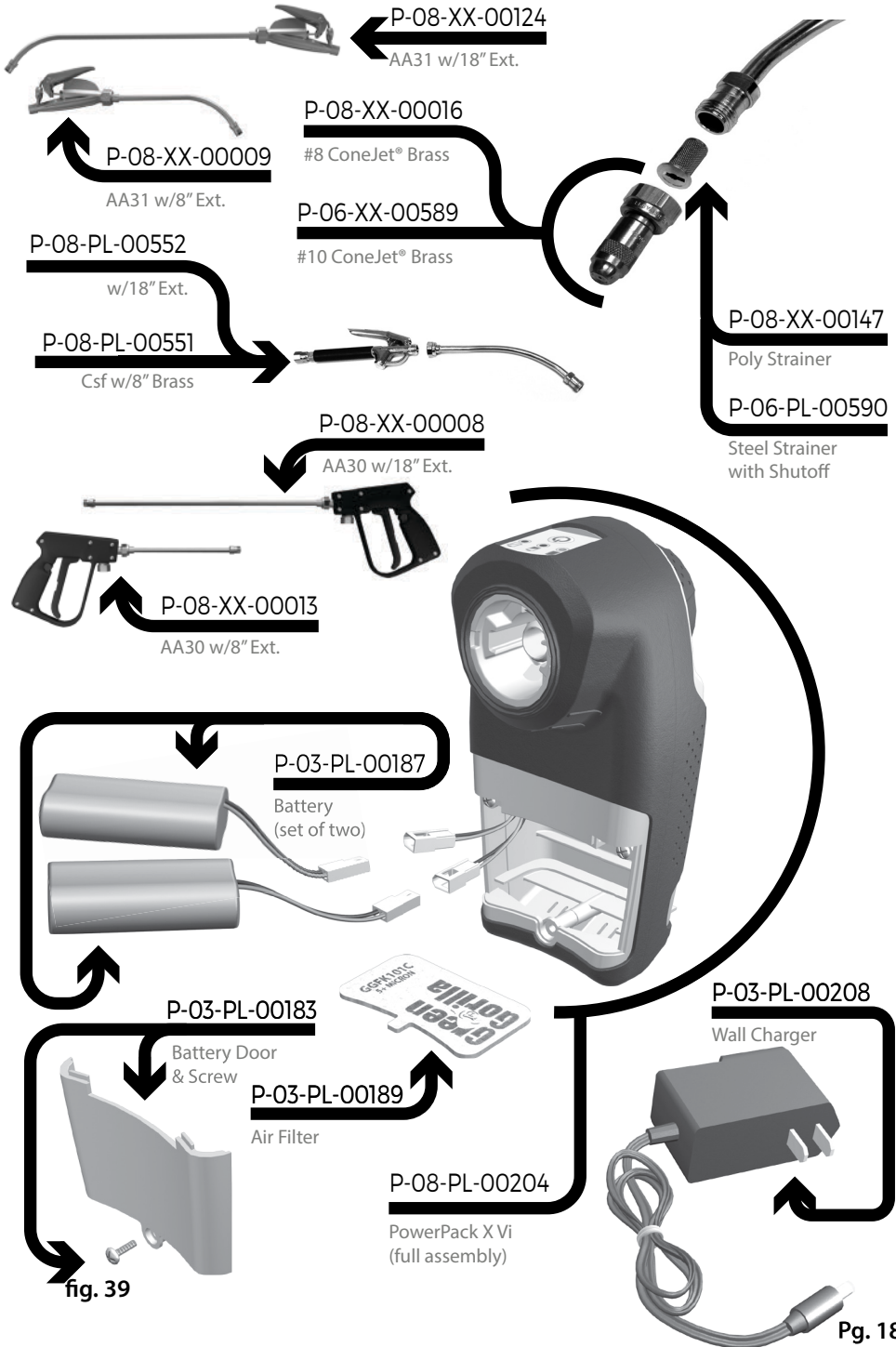

fig. 38

PowerPack Replacement Parts



LIMITED WARRANTY

(USA & Canada Only)

ForeFront Product Design LLC warrants its ProLine™ Spray System for a period of one year from the date of original purchase. We will repair or replace at our option, any part or parts of the product and accessories covered under this warranty which examination proves to be defective in workmanship or material during the warranty period.

For repair or replacement return the complete system or accessory, transportation prepaid, to ForeFront Product Design LLC, 568 Braddock Ave, East Pittsburgh, PA 15112, USA, or to an alternate address provided by customer support.

Proof of purchase may be required. This warranty does not apply to repair or replacement required due to misuse, abuse, normal wear and tear or repairs attempted or made by other than or Service Center.

Under no circumstances will ForeFront Product Design LLC be liable for incidental or consequential damages resulting from defective products.

This warranty is ForeFront Product Design's sole warranty and sets forth the customer's exclusive remedy, with respect to defective products; all other warranties, expressed or implied, whether of merchantability, fitness for purpose, or otherwise, are expressly disclaimed by ForeFront Product Design, LLC.



ForeFront Product Design, LLC
PO Box 18273
Pittsburgh, PA 15236

® Customer Service
+1 800 866 2122
www.green-gorilla.com